

DEL-P



Linear slot diffuser with adjustable PVC deflectors without predisposition for damper and equalizer, with a high induction ratio (mixing capacity) between inlet air and ambient air.

Consisting of aluminum profiles coupled to obtain multiple slits inside which adjustable plastic deflectors are housed. The flow of the incoming air can be oriented in the right, left or alternating direction, by varying the position of the deflectors.

TECHNICAL SPECIFICATION AND USAGE LIMIT

INSTALLATION HEIGHT	APPLICATIONS	MATERIAL	STANDARD FINISHING	ON REQUEST FINISHING	FASTENING TO PLENUM
2,5 to 4m	The DEL diffuser can also be used for air return; in this case it is supplied without deflecting fins. The deflectors can also be oriented after the diffuser has been installed in order to make adjustments to optimise airflow in the room once the system is running.	Extruded anodized aluminium profiles, ABS supports and black PVC deflector	Anodized aluminum or white RAL 9010 - Black PVC deflectors (white PVC on request)	On request, frame painting in non-standard RAL colors - Non-paintable deflectors	By means of anchoring bridges on the plenum

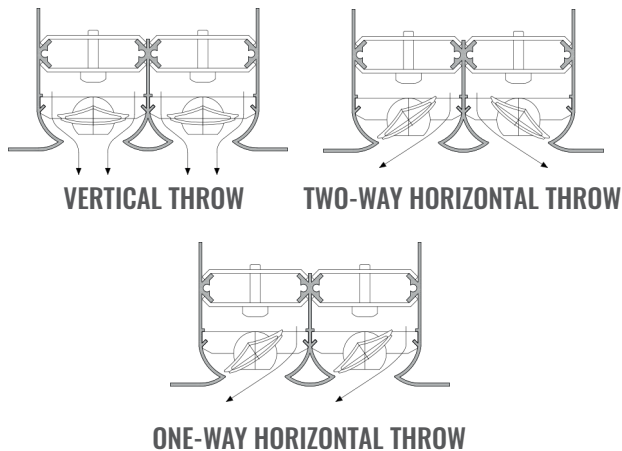

GREEN BUILDING

Thanks also to the support of GreenMap, products manufactured by Tecnica srl contribute to obtain the credits of the major international rating systems for sustainable buildings:



LEED

Contributes to credits:
IP, EA, MR, EQ



WELL

Contributes to credits:
AIR, THERMAL COMFORT,
MATERIALS, COMMUNITY

BREEAM®

BREEAM

Contributes to credits:
MAN, HEA, WST

For further details about specific contributions to the credits indicated, contact Tecnica Srl









TECHNICAL DATA

Length [mm]	Slot [n.]	L1 [mm]	L2 [mm]	L3 [mm]	A [mm]	B [mm]	C [mm]
800	1	800	797	829,8	44,4	67,0	56,2
	2	800	797	829,8	87,6	110,2	56,2
	3	800	797	829,8	130,8	153,4	56,2
	4	800	797	829,8	174,0	196,6	56,2
1000	1	1000	997	1029,8	44,4	67,0	56,2
	2	1000	997	1029,8	87,6	110,2	56,2
	3	1000	997	1029,8	130,8	153,4	56,2
	4	1000	997	1029,8	174,0	196,6	56,2

TECHNICAL DATA

Length [mm]	Slot n.	L1 [mm]	L2 [mm]	L3 [mm]	A [mm]	B [mm]	C [mm]
1500	1	1500	1497	1529,8	44,4	67,0	56,2
	2	1500	1497	1529,8	87,6	110,2	56,2
	3	1500	1497	1529,8	130,8	153,4	56,2
	4	1500	1497	1529,8	174,0	196,6	56,2
2000	1	2000	1997	2029,8	44,4	67,0	56,2
	2	2000	1997	2029,8	87,6	110,2	56,2
	3	2000	1997	2029,8	130,8	153,4	56,2
	4	2000	1997	2029,8	174,0	196,6	56,2

APPLICATIONS

								
Residential	Easy Pack	Calculation Method	REACH Certificat	RoHS Certificat	Industry	Building	Air Conditioning	Interior design

*on request

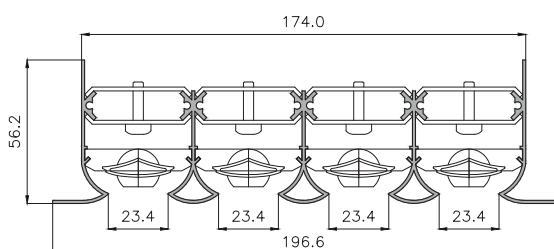
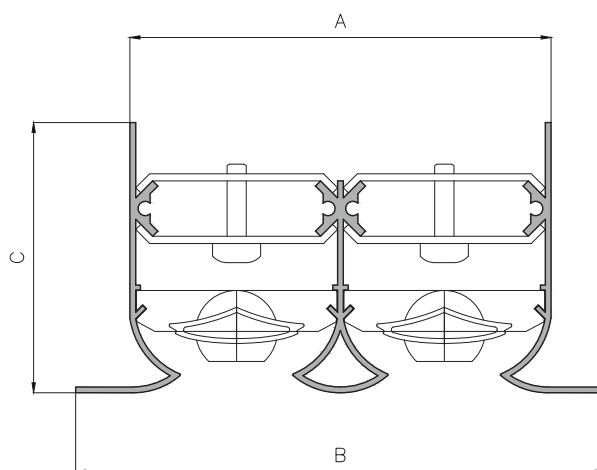
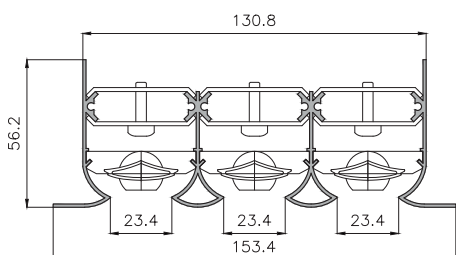
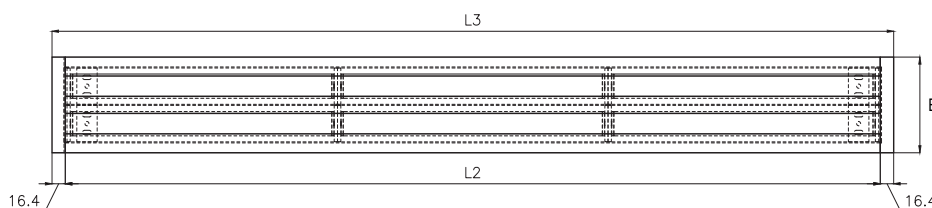
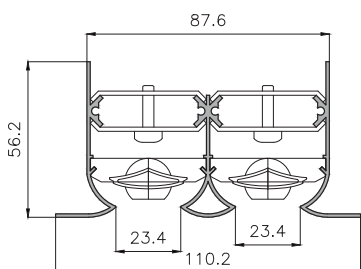
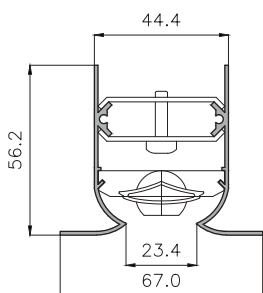

Selection Charts

Flow Rate / Pressure Drop / Noise Level
Models DEL - 1 Slot

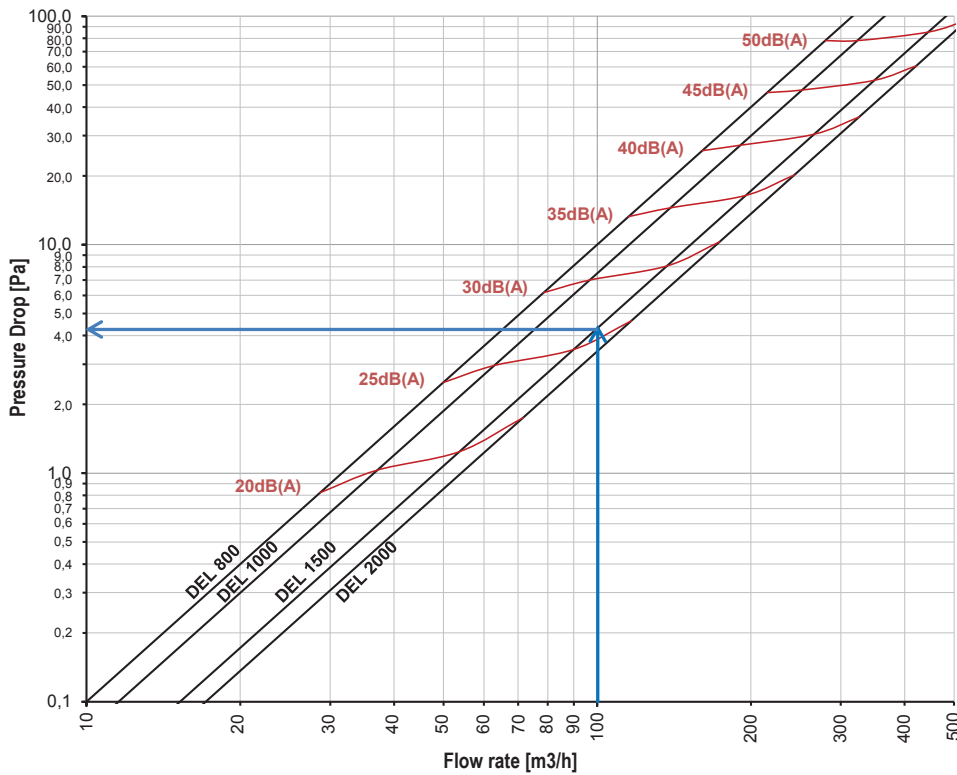

Diagram 1 - 1 slot

The diagram shows the pressure drop of the diffuser based on the flow rate with relative indication of the sound power level without environmental attenuation.

CALCULATION (input data)

Total Flow Rate	100 m ³ /h
Max Noise Level	<30dB(A).
Horizontal Throw	4,0m.
Vertical Throw	2,8m

Flow Rate / Pressure Drop / Noise Level
Models DEL - 2 Slot

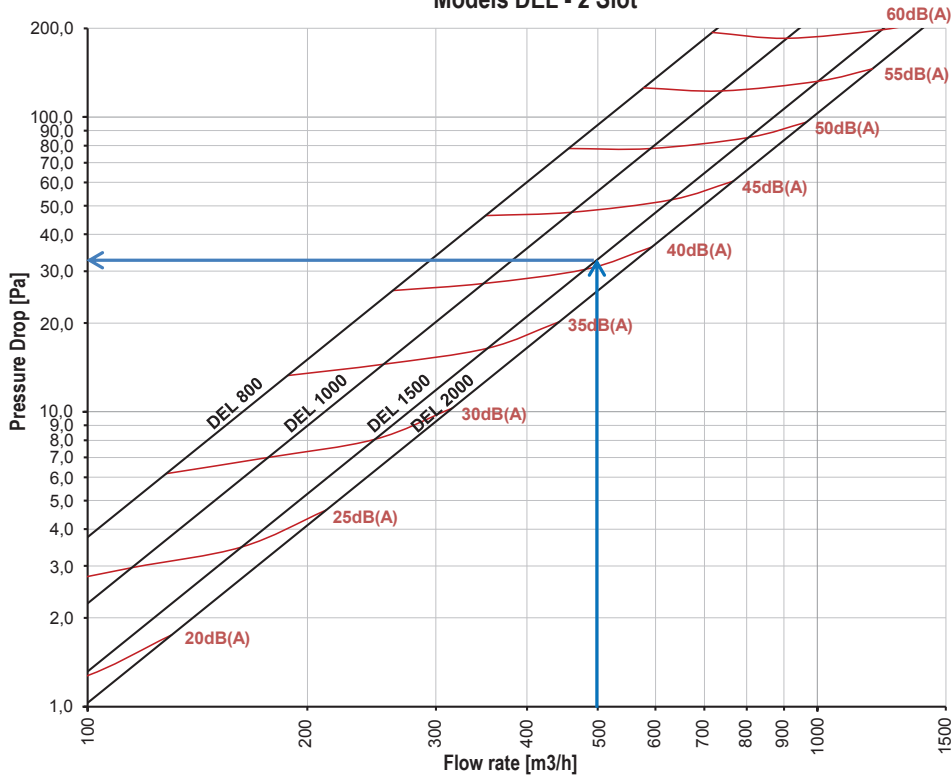

SELECTION

Model	DEL 1500 1 SLOT
Flow Rate	107 m ³ /h
Pressure Drop	5Pa
Noise Level	27dB(A)
Inlet Air Speed	2m/s
Horizontal Isothermal Throw	4,0m
Vertical Isothermal Throw	2,8m

Diagram 2 - 2 slots

Note: Pressure drop data shown in the diagram refer to the diffuser with the damper fully open.

Flow Rate / Pressure Drop / Noise Level
Models DEL - 3 Slot

Diagram 3 - 3 slots

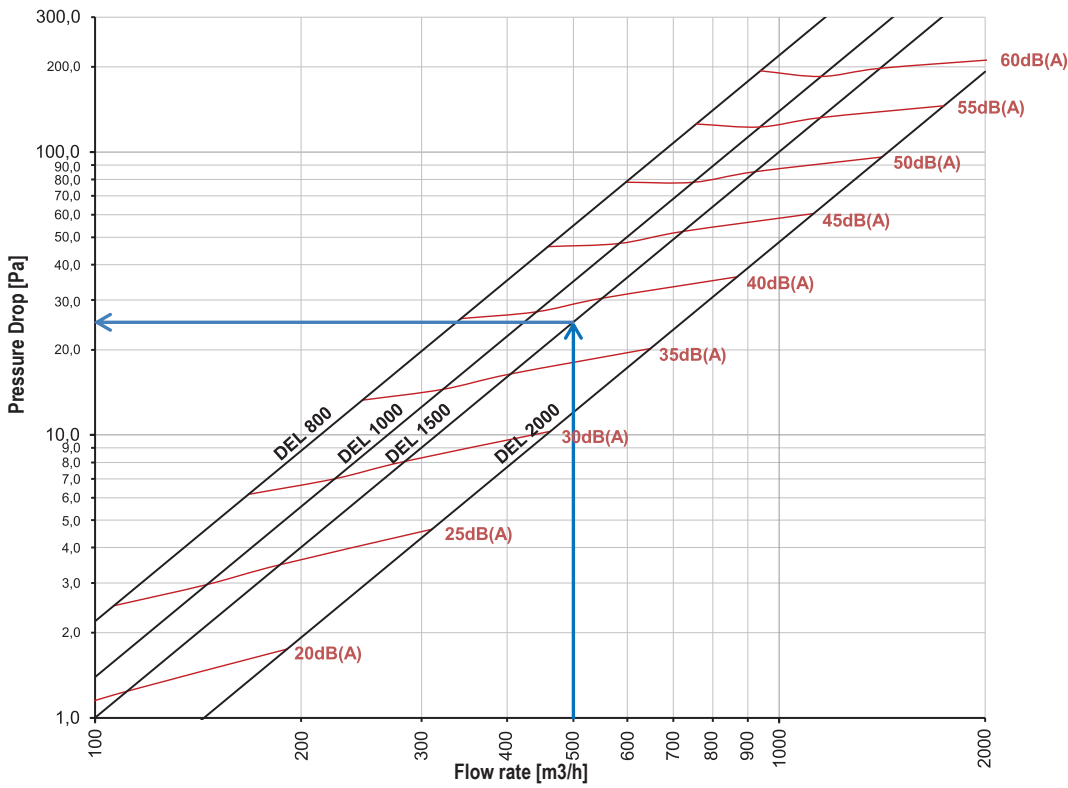

Flow Rate / Pressure Drop / Noise Level
Models DEL - 2 Slot

Diagram 4 - 4 slots

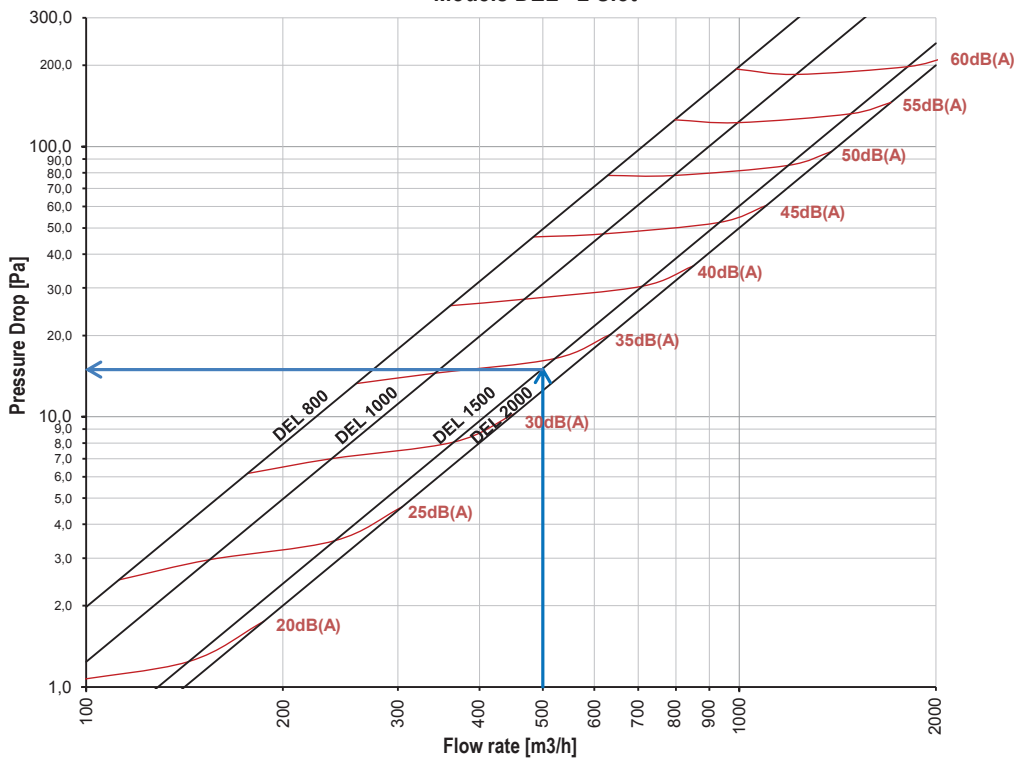

QUICK SELECTION TABLE - L. 800mm - ISOTHERMAL CONDITIONS

MODEL	DESCRIPTION	U.M.	Vi (m/sec)									
			1	2	3	4	5	6	7	8	9	10
DEL 800 1 SLOT Ak: 0,0080m ²	Flow Rate	m ³ /h	29	57	86	115	143	172	201	229	258	287
	Pressure Drop	Pa	1	3	7	13	21	30	40	53	67	82
	Horizontal Throw Vt 0,25	mt	1,1	2,1	3,2	4,2	5,3	6,3	7,4	8,4	9,5	10,6
	Vertical Throw Vt 0,25	mt	0,7	1,5	2,2	3,0	3,7	4,4	5,2	5,9	6,6	7,4
	Noise Level	dB(A)	20	26	31	35	38	41	44	46	48	50
DEL 800 2 SLOT Ak: 0,0159m ²	Flow Rate	m ³ /h	57	115	172	229	287	344	401	458	516	573
	Pressure Drop	Pa	1	5	11	20	31	44	61	79	100	124
	Horizontal Throw Vt 0,25	mt	1,5	3,0	4,5	6,0	7,5	9,0	10,5	12,0	13,5	15,0
	Vertical Throw Vt 0,25	mt	1,0	2,1	3,1	4,2	5,2	6,3	7,3	8,4	9,4	10,5
	Noise Level	dB(A)	22	29	34	38	41	45	47	50	53	55
DEL 800 3 SLOT Ak: 0,0239m ²	Flow Rate	m ³ /h	86	172	258	344	430	516	602	688	774	860
	Pressure Drop	Pa	2	6	15	26	41	58	80	104	131	162
	Horizontal Throw Vt 0,25	mt	1,8	3,5	5,3	7,1	8,9	10,6	12,4	14,2	15,9	17,7
	Vertical Throw Vt 0,25	mt	1,2	2,5	3,7	5,0	6,2	7,4	8,7	9,9	11,2	12,4
	Noise Level	dB(A)	23	30	36	40	44	47	50	53	56	58
DEL 800 4 SLOT Ak: 0,0318m ²	Flow Rate	m ³ /h	115	229	344	458	573	688	802	917	1032	1146
	Pressure Drop	Pa	3	10	23	42	65	94	127	166	211	260
	Horizontal Throw Vt 0,25	mt	2,0	4,0	6,1	8,1	10,1	12,1	14,1	16,2	18,2	20,2
	Vertical Throw Vt 0,25	mt	1,4	2,8	4,2	5,7	7,1	8,5	9,9	11,3	12,7	14,1
	Noise Level	dB(A)	25	33	39	44	48	52	55	58	61	64

Note: the data indicated refer to operation in isothermal conditions

QUICK SELECTION TABLE - L. 1000mm - ISOTHERMAL CONDITIONS

MODEL	DESCRIPTION	U.M.	Vi (m/sec)									
			1	2	3	4	5	6	7	8	9	10
DEL 1000 1 SLOT Ak: 0,0099m ²	Flow Rate	m ³ /h	36	72	107	143	179	215	251	287	322	358
	Pressure Drop	Pa	1	4	9	15	24	35	47	61	78	96
	Horizontal Throw Vt 0,25	mt	1,3	2,6	4,0	5,3	6,6	7,9	9,2	10,5	11,9	13,2
	Vertical Throw Vt 0,25	mt	0,9	1,8	2,8	3,7	4,6	5,5	6,5	7,4	8,3	9,2
	Noise Level	dB(A)	20	26	31	35	39	42	45	48	50	52
DEL 1000 2 SLOT Ak: 0,0199m ²	Flow Rate	m ³ /h	72	143	215	287	358	430	501	573	645	716
	Pressure Drop	Pa	1	5	10	18	29	41	56	74	93	115
	Horizontal Throw Vt 0,25	mt	1,9	3,8	5,6	7,5	9,4	11,3	13,2	15,1	16,9	18,8
	Vertical Throw Vt 0,25	mt	1,3	2,6	4,0	5,3	6,6	7,9	9,2	10,5	11,9	13,2
	Noise Level	dB(A)	20	27	33	37	40	44	47	49	52	54
DEL 1000 3 SLOT Ak: 0,0298m ²	Flow Rate	m ³ /h	107	215	322	430	537	645	752	860	967	1075
	Pressure Drop	Pa	2	6	14	26	40	58	79	103	130	161
	Horizontal Throw Vt 0,25	mt	2,2	4,4	6,7	8,9	11,1	13,3	15,6	17,8	20,0	22,2
	Vertical Throw Vt 0,25	mt	1,6	3,1	4,7	6,2	7,8	9,3	10,9	12,4	14,0	15,6
	Noise Level	dB(A)	22	29	35	40	43	47	50	53	56	58
DEL 1000 4 SLOT Ak: 0,0398m ²	Flow Rate	m ³ /h	143	287	430	573	716	860	1003	1146	1290	1433
	Pressure Drop	Pa	3	10	23	41	64	92	125	163	206	255
	Horizontal Throw Vt 0,25	mt	2,5	5,0	7,6	10,1	12,6	15,1	17,6	20,2	22,7	25,2
	Vertical Throw Vt 0,25	mt	1,8	3,5	5,3	7,1	8,8	10,6	12,4	14,1	15,9	17,6
	Noise Level	dB(A)	24	32	39	44	48	52	55	58	61	64

Note: the data indicated refer to operation in isothermal conditions

QUICK SELECTION TABLE - L. 1500mm - ISOTHERMAL CONDITIONS

MODEL	DESCRIPTION	U.M.	Vi (m/sec)									
			1	2	3	4	5	6	7	8	9	10
DEL 1500 1 SLOT Ak: 0,0149m ²	Flow Rate	m ³ /h	54	107	161	215	269	322	376	430	484	537
	Pressure Drop	Pa	1	5	11	20	31	45	61	79	101	124
	Horizontal Throw Vt 0,25	mt	2,0	4,0	5,9	7,9	9,9	11,9	13,9	15,9	17,8	19,8
	Vertical Throw Vt 0,25	mt	1,4	2,8	4,2	5,6	6,9	8,3	9,7	11,1	12,5	13,9
	Noise Level	dB(A)	20	27	32	36	40	43	46	49	52	54
DEL 1500 2 SLOT Ak: 0,0298m ²	Flow Rate	m ³ /h	107	215	322	430	537	645	752	860	967	1075
	Pressure Drop	Pa	2	6	14	24	38	55	74	97	123	152
	Horizontal Throw Vt 0,25	mt	2,9	5,7	8,6	11,5	14,4	17,2	20,1	23,0	25,9	28,7
	Vertical Throw Vt 0,25	mt	2,0	4,0	6,0	8,0	10,1	12,1	14,1	16,1	18,1	20,1
	Noise Level	dB(A)	21	28	34	38	42	45	49	51	54	57
DEL 1500 3 SLOT Ak: 0,0448m ²	Flow Rate	m ³ /h	161	322	484	645	806	967	1128	1290	1451	1612
	Pressure Drop	Pa	3	10	23	42	65	94	128	167	211	260
	Horizontal Throw Vt 0,25	mt	3,4	6,7	10,1	13,5	16,8	20,2	23,6	26,9	30,3	33,7
	Vertical Throw Vt 0,25	mt	2,4	4,7	7,1	9,4	11,8	14,1	16,5	18,8	21,2	23,6
	Noise Level	dB(A)	23	32	38	43	47	51	55	58	61	64
DEL 1500 4 SLOT Ak: 0,0597m ²	Flow Rate	m ³ /h	215	430	645	860	1075	1290	1504	1719	1934	2149
	Pressure Drop	Pa	3	11	25	45	70	100	136	178	226	278
	Horizontal Throw Vt 0,25	mt	3,8	7,6	11,4	15,2	19,0	22,8	26,6	30,4	34,1	37,9
	Vertical Throw Vt 0,25	mt	2,7	5,3	8,0	10,6	13,3	15,9	18,6	21,2	23,9	26,6
	Noise Level	dB(A)	24	32	38	43	48	52	55	59	62	65

Note: the data indicated refer to operation in isothermal conditions

QUICK SELECTION TABLE - L. 2000mm - ISOTHERMAL CONDITIONS

MODEL	DESCRIPTION	U.M.	Vi (m/sec)									
			1	2	3	4	5	6	7	8	9	10
DEL 2000 1 SLOT Ak: 0,0199m ²	Flow Rate	m ³ /h	72	143	215	287	358	430	501	573	645	716
	Pressure Drop	Pa	2	7	16	28	44	63	86	112	142	175
	Horizontal Throw Vt 0,25	mt	2,6	5,3	7,9	10,6	13,2	15,9	18,5	21,2	23,8	26,5
	Vertical Throw Vt 0,25	mt	1,9	3,7	5,6	7,4	9,3	11,1	13,0	14,8	16,7	18,5
	Noise Level	dB(A)	20	27	33	38	42	45	49	52	55	57
DEL 2000 2 SLOT Ak: 0,0398m ²	Flow Rate	m ³ /h	143	287	430	573	716	860	1003	1146	1290	1433
	Pressure Drop	Pa	2	8	19	34	53	76	104	135	171	211
	Horizontal Throw Vt 0,25	mt	3,9	7,8	11,6	15,5	19,4	23,3	27,1	31,0	34,9	38,8
	Vertical Throw Vt 0,25	mt	2,7	5,4	8,1	10,9	13,6	16,3	19,0	21,7	24,4	27,1
	Noise Level	dB(A)	21	29	35	39	44	47	51	54	57	60
DEL 2000 3 SLOT Ak: 0,0597m ²	Flow Rate	m ³ /h	215	430	645	860	1075	1290	1504	1719	1934	2149
	Pressure Drop	Pa	2	9	20	36	56	80	109	142	180	222
	Horizontal Throw Vt 0,25	mt	4,5	9,0	13,5	18,1	22,6	27,1	31,6	36,1	40,6	45,1
	Vertical Throw Vt 0,25	mt	3,2	6,3	9,5	12,6	15,8	19,0	22,1	25,3	28,4	31,6
	Noise Level	dB(A)	21	29	35	40	44	48	51	55	58	61
DEL 2000 4 SLOT Ak: 0,0796m ²	Flow Rate	m ³ /h	287	573	860	1146	1433	1719	2006	2292	2579	2866
	Pressure Drop	Pa	4	16	37	66	103	148	201	263	333	411
	Horizontal Throw Vt 0,25	mt	5,1	10,1	15,2	20,2	25,3	30,4	35,4	40,5	45,6	50,6
	Vertical Throw Vt 0,25	mt	3,5	7,1	10,6	14,2	17,7	21,3	24,8	28,3	31,9	35,4
	Noise Level	dB(A)	24	33	40	46	51	55	59	63	66	70

Note: the data indicated refer to operation in isothermal conditions