



DCSC Therm

Circular diffuser with adjustable cones made up of concentric truncated cone profiles, adjustable in height by means of a screw in order to change the direction of the air jet in relation to the required thermal conditions.

The internal cone is closed with a flat panel that gives the diffuser a pleasant aesthetic appearance without penalizing the functional specifications.

The adjustment by means of a thermostatic spring system allows to independently change the position of the cones based on the temperature of the air flow introduced.

TECHNICAL SPECIFICATION AND USAGE LIMIT

INSTALLATION HEIGHT	APPLICATIONS	MATERIALS	SURFACE FINISH	COLOR	FASTENING
2,7 to 6 m	Room cooling and heating	Aluminium and steel	Epoxy powder coating resistant to impact and abrasion	Standard RAL 9010 - glossy RAL 9016 - glossy RAL 9003 - mat	by means of screws positioned on the diffuser neck

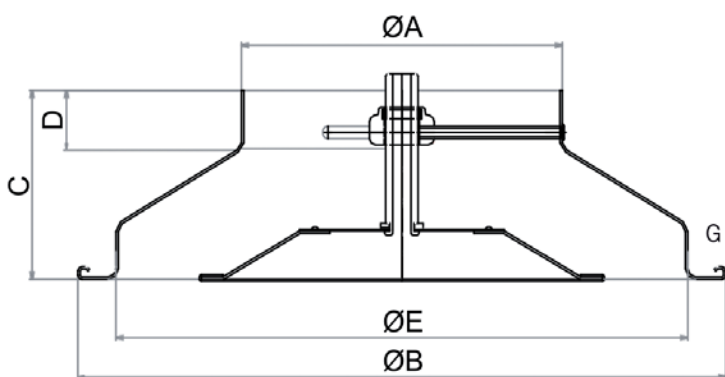

GREEN BUILDING

Thanks also to the support of GreenMap, products manufactured by Tecnica srl contribute to obtain the credits of the major international rating systems for sustainable buildings:



LEED

Contributes to credits:
IP, EA, MR, EQ



WELL

Contributes to credits:
THERMAL COMFORT,
MATERIALS, COMMUNITY



BREEAM









Contributes to credits:
MAN, HEA, WST

For further details about specific contributions to the credits indicated, contact Tecnica Srl

TECHNICAL DATA

Model	Ø A [mm]	Ø B [mm]	Ø E [mm]	Ø FORO [mm]	C [mm]	D [mm]	G [mm]
DCSC 100	96	250	195	225	85	33	25
DCSC 150	146	330	280	308	90	25	23
DCSC 160	156	330	280	308	90	27	23
DCSC 200	196	445	370	410	115	37	35
DCSC 250	246	535	460	500	135	37	35

APPLICATIONS

								
Residential	Easy Pack	Calculation Method	REACH Certificate	RoHS Certificate	Industry	Building	Air Conditioning	Interior design

*on request

Selection charts

Flow Rate / Pressure Drop
Noise Level / Air Speed

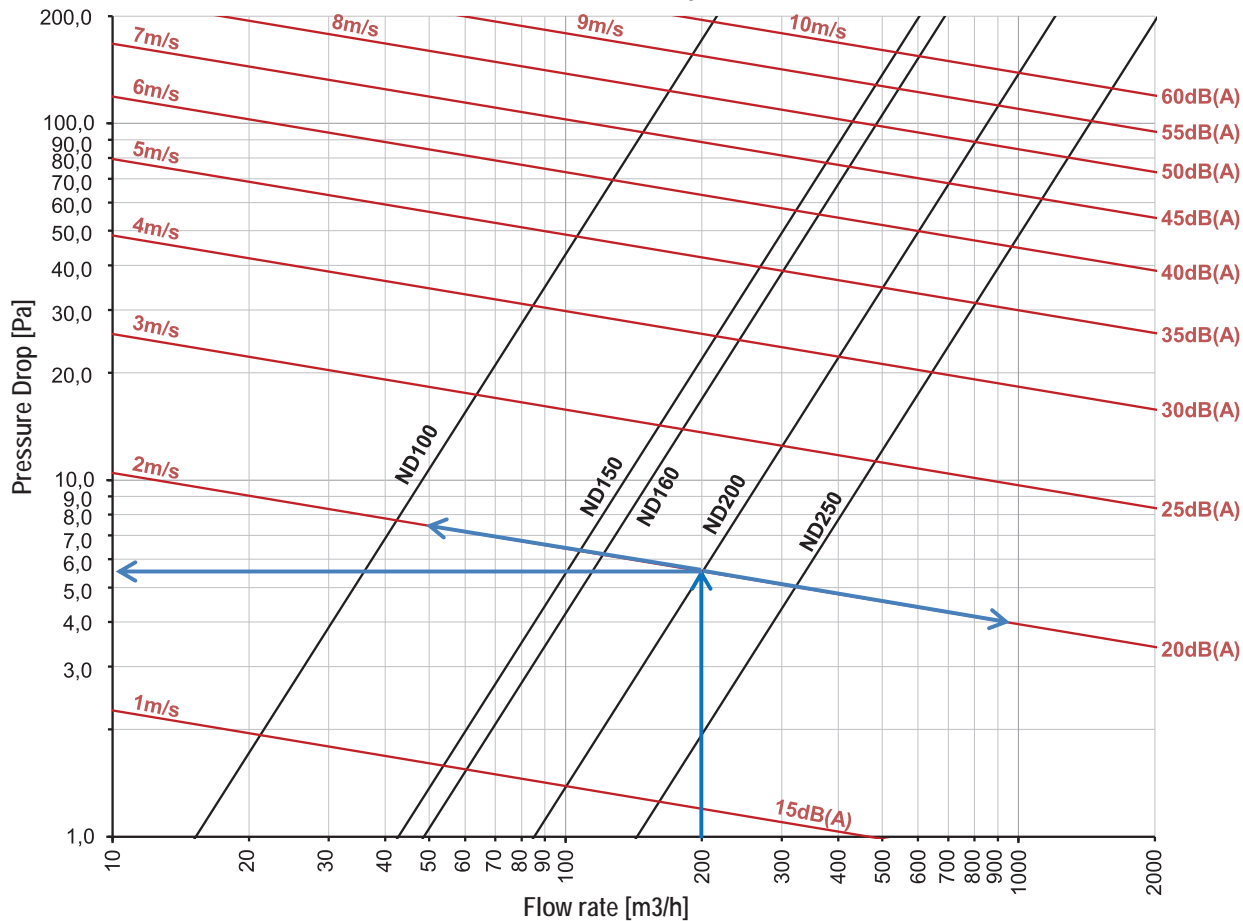

Diagram 1

The diagram shows the pressure drop of the diffuser based on the flow rate with relative indication of the noise level without environmental attenuation and speed of the incoming air flow.

CALCULATION (input data)

Total Flow Rate	2000 m ³ /h
Max. Noise Level	20dB(A)
Number of diffusers expected	10pz.
Throw	1,20m

Flow Rate / Isothermal Throw (Vt.: 0,25m/s)

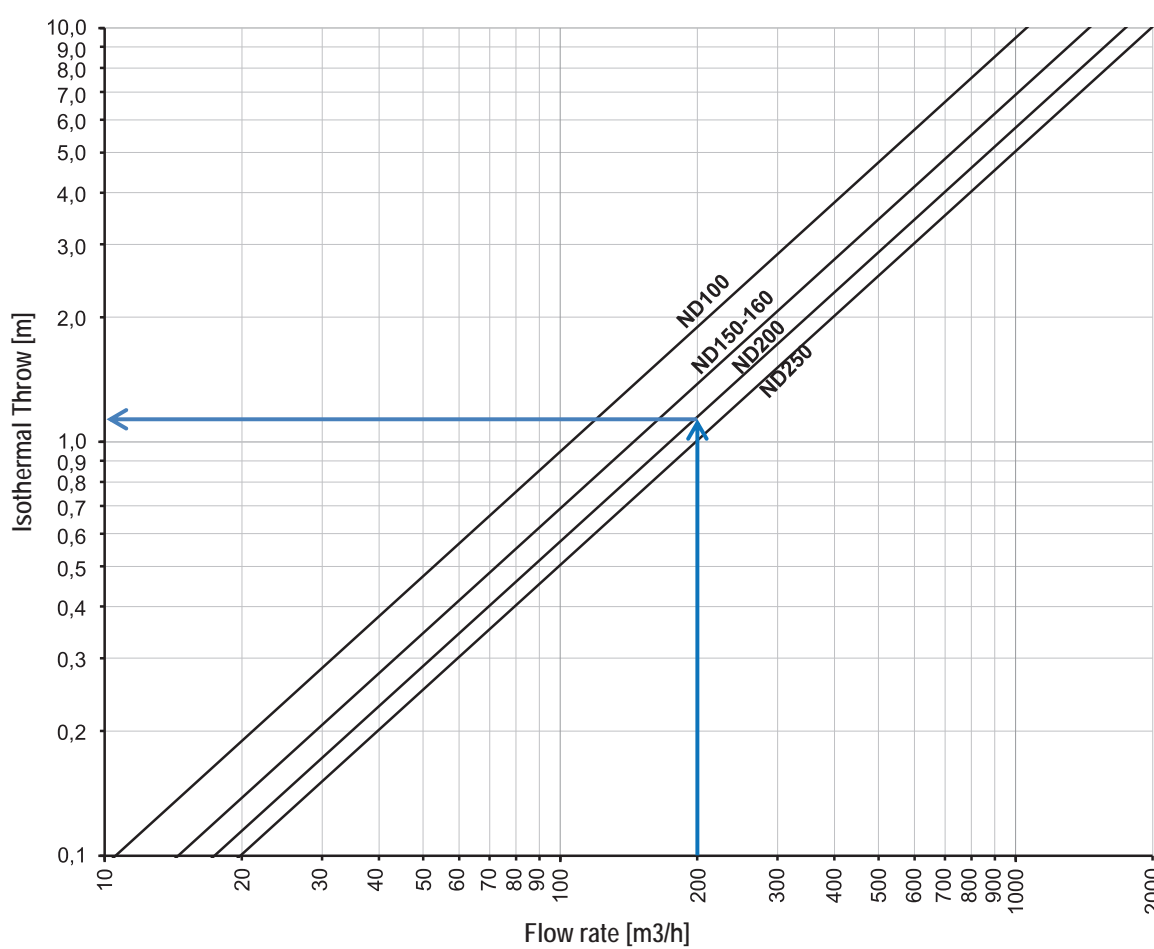

SELECTION

Model	DCSC 200
Flow Rate	200 m ³ /h
Pressure Drop	+/- 5,5Pa
Noise Level	20dB(A)
Air Speed	2,0m/s
Isothermal Throw	+/- 1,20m

Diagram 2

The diagram shows the isothermal launch of the diffuser according to the flow rate with terminal speed (Vt) of 0,25m/s. The horizontal launch data are to be understood in isothermal conditions.

For $\Delta T < 10^{\circ}\text{C}$ multiply the horizontal throw by 0,85.

NOTE: Pressure drop data shown in the diagram refer to the diffuser with the damper fully open.

MODEL	DESCRIPTION	U.M.	Vi (m/sec)									
			1	2	3	4	5	6	7	8	9	10
100 Ak: 0,0059m ²	Flow Rate	m ³ /h	21	42	63	84	105	127	148	169	190	211
	Pressure Drop	Pa	1,9	7,6	17,2	30,6	47,7	68,7	93,6	122,2	154,7	191,0
	Horizontal Throw Vt 0,25	mt	0,2	0,4	0,6	0,8	1,0	1,2	1,4	1,6	1,8	2,0
	Noise Level	dB(A)	15	20	25	30	35	40	45	50	55	60
	Min. Installation height	mt	2,5	2,6	2,7	2,8	2,9	3,0	3,1	3,2	3,3	3,4
	Max. Installation height	mt	3,2	3,3	3,4	3,5	3,6	3,7	3,8	3,9	4,0	4,1
150 Ak: 0,0149m ²	Flow Rate	m ³ /h	54	107	161	215	268	322	376	429	483	537
	Pressure Drop	Pa	1,6	6,3	14,2	25,2	39,4	56,8	77,3	101,0	127,8	157,7
	Horizontal Throw Vt 0,25	mt	0,4	0,7	1,1	1,5	1,9	2,2	2,6	3,0	3,3	3,7
	Noise Level	dB(A)	15	20	25	30	35	40	45	50	55	60
	Min. Installation height	mt	2,5	2,6	2,7	2,8	2,9	3,0	3,1	3,2	3,3	3,4
	Max. Installation height	mt	3,2	3,3	3,4	3,5	3,6	3,7	3,8	3,9	4,0	4,1
160 Ak: 0,0167m ²	Flow Rate	m ³ /h	60	120	181	241	301	361	421	482	542	602
	Pressure Drop	Pa	1,5	6,1	13,8	24,5	38,3	55,1	75,0	98,0	124,0	153,1
	Horizontal Throw Vt 0,25	mt	0,4	0,8	1,2	1,7	2,1	2,5	2,9	3,3	3,7	4,1
	Noise Level	dB(A)	15	20	25	30	35	40	45	50	55	60
	Min. Installation height	mt	2,5	2,6	2,7	2,8	2,9	3,0	3,1	3,2	3,3	3,4
	Max. Installation height	mt	3,2	3,3	3,4	3,5	3,6	3,7	3,8	3,9	4,0	4,1
200 Ak: 0,0279m ²	Flow Rate	m ³ /h	100	201	301	402	502	602	703	803	904	1004
	Pressure Drop	Pa	1,4	5,5	12,5	22,2	34,7	49,9	68,0	88,8	112,3	138,7
	Horizontal Throw Vt 0,25	mt	0,6	1,2	1,7	2,3	2,9	3,5	4,0	4,6	5,2	5,8
	Noise Level	dB(A)	15	20	25	30	35	40	45	50	55	60
	Min. Installation height	mt	2,5	2,6	2,7	2,8	2,9	3,0	3,1	3,2	3,3	3,4
	Max. Installation height	mt	3,2	3,3	3,4	3,5	3,6	3,7	3,8	3,9	4,0	4,1
250 Ak: 0,0448m ²	Flow Rate	m ³ /h	161	323	484	645	806	968	1129	1290	1451	1613
	Pressure Drop	Pa	1,3	5,0	11,3	20,1	31,5	45,3	61,7	80,5	101,9	125,8
	Horizontal Throw Vt 0,25	mt	0,8	1,6	2,4	3,2	4,1	4,9	5,7	6,5	7,3	8,1
	Noise Level	dB(A)	15	20	25	30	35	40	45	50	55	60
	Min. Installation height	mt	2,5	2,6	2,7	2,8	2,9	3,0	3,1	3,2	3,3	3,4
	Max. Installation height	mt	3,2	3,3	3,4	3,5	3,6	3,7	3,8	3,9	4,0	4,1

Note: the data indicated refer to operation in isothermal conditions

ASSEMBLY INSTRUCTION



Thermostatic System Detail

The self-adjusting system for the central cones is made with harmonic steel springs with a thermostatic effect which allow to correctly relocate the central body of the diffuser based on the temperature of the air introduced to obtain the appropriate throw.

INSTALLATION WITH CONNECTING SLEEVE AND BUTTERFLY DAMPER

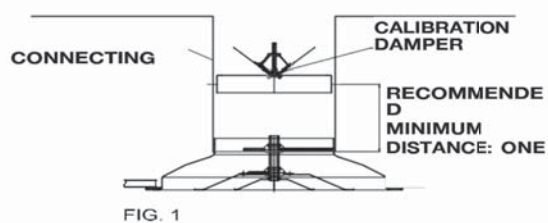

FIG. 1

INSTALLATION WITH FLEXIBLE HOSE AND BUTTERFLY DAMPER

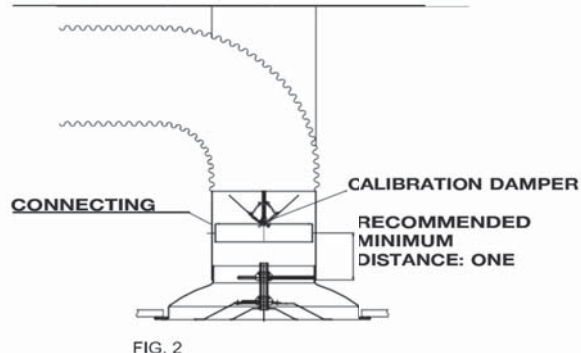

FIG. 2

INSTALLATION WITH CONNECTING SLEEVE AND COLLECTION DAMPER

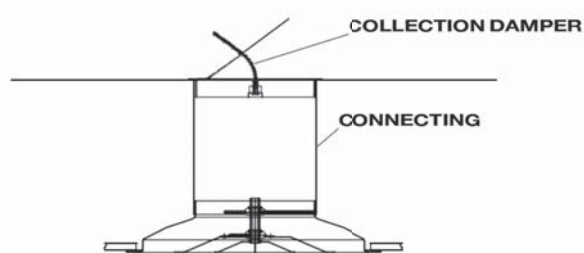

FIG. 3

Easy installation, adjustments and maintenance. The intermediate cones are easy to remove by turning the central hollow threaded pin. The damper fitted at the top of the diffuser is adjusted by acting on the adjustment screw through the hole in the threaded bar of the diffuser. It is fastened to the ceiling by means of screws on the diffuser neck.

Adjustment

Central cone in low position: optimal position in cooling conditions in order to have the largest horizontal diffusion radius without creating discomfort in the occupied area in rooms with an ideal height between 3 and 4 m. With this configuration, you have the best pressure drop, velocity and sound level conditions. The maximum temperature difference (DI) between the ambient air and the air flowing from the diffuser to obtain the optimal induction conditions is 12°C.

Central cone in high position: optimal position for particularly high rooms up to 6 m and in heating conditions, as you obtain a vertical throw that resists the convective motion of the ambient air.

Fig. 1 Installation with butterfly damper

- Fit the damper on the connecting sleeve, if possible keeping a distance with respect to the diffuser of one nominal diameter but not less than 5 cm.
- Unscrew the central cones from the diffuser and fasten the external housing on the connecting sleeve.
- Screw the central cones onto the external housing.
- Adjust the internal cones according to the desired diffusion parameters.
- Adjust the damper through the central hole in the threaded bar of the diffuser.

Fig. 2 Installation on flexible hose with butterfly damper

- Hang the diffuser on the ceiling or fasten it on the false ceiling.
- Fasten the damper on the connecting sleeve.
- Fit the connecting sleeve in the diffuser.
- Fit the flexible duct on the connecting sleeve and fasten it with a hose clamp.

Fig. 3 Installation with connecting sleeve and collection damper

- Fit the damper on the connecting sleeve in proximity of the hole in the main duct and fasten it with screws or rivets.
- Adjust the damper.
- Fasten the diffuser on the connecting sleeve.
- Finally adjust the flow rate by acting on the damper through the central hole in the threaded bar.