



DCMC

building
information
modeling **BIM**

High-induction circular diffuser with adjustable cones made up of concentric truncated cone profiles. Height adjustable by means of an adjustment screw in order to change the direction of the air jet in relation to the required thermal conditions.

- **INSTALLATION HEIGHT::** da 2,7 a 6 m
- **APPLICATION:** room cooling and heating

TECHNICAL SPECIFICATION AND USAGE LIMIT

INSTALLATION HEIGHT	APPLICATIONS	MATERIALS	SURFACE FINISH	COLOR	FASTENING
2,7 to 6 m	Room cooling and heating	Aluminium and steel	Epoxy powder coating resistant to impact and abrasion	Standard RAL 9010 - glossy RAL 9016 - glossy RAL 9003 - mat	by means of screws positioned on the diffuser neck

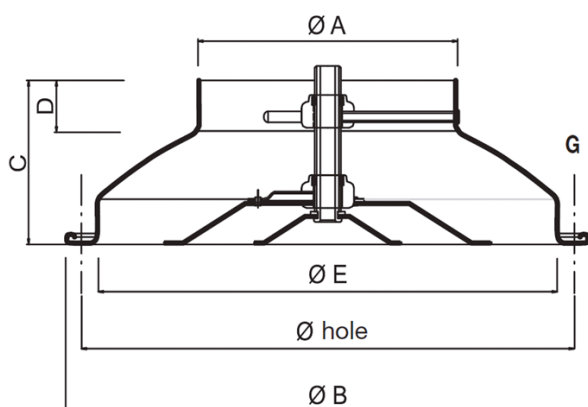

GREEN BUILDING

Thanks also to the support of GreenMap, products manufactured by Tecnica srl contribute to obtain the credits of the major international rating systems for sustainable buildings:



LEED

Contributes to credits:
IP, EA, MR



WELL

Contributes to credits:
MATERIALS, COMMUNITY

BREEAM

BREEAM









Contributes to credits:
MAN, WST

For further details about specific contributions to the credits indicated, contact Tecnica Srl

TECHNICAL DATA

Model	Ø A [mm]	Ø B [mm]	Ø E [mm]	Ø foro [mm]	C [mm]	D [mm]	G [mm]
DCMC 100	96	250	195	225	85	33	25
DCMC 150	146	330	280	308	90	25	23
DCMC 160	156	330	280	308	90	27	23
DCMC 200	196	445	370	410	115	37	35
DCMC 250	246	535	460	500	135	37	35
DCMC 300	296	655	560	610	170	45	45
DCMC 315	311	655	560	610	170	48	45
DCMC 350	346	763	650	709	195	60	54
DCMC 400	396	793	680	740	195	60	52
DCMC 450	444	843	730	790	195	60	52
DCMC 500	496	893	782	842	195	60	52
DCMC 630	624	1045	929	991	210	55	54

APPLICATIONS

								
Residential	Easy Pack	Calculation Method	REACH Certificat	RoHS Certificat	Industry	Building	Air Conditioning	Interior design

*on request

Selection charts

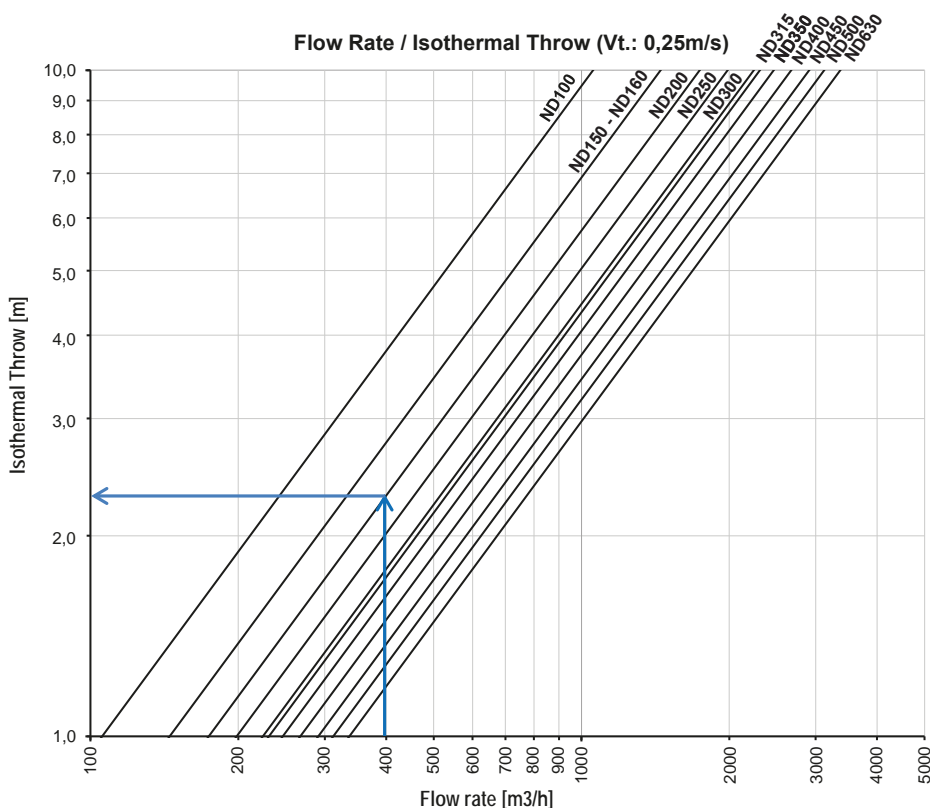
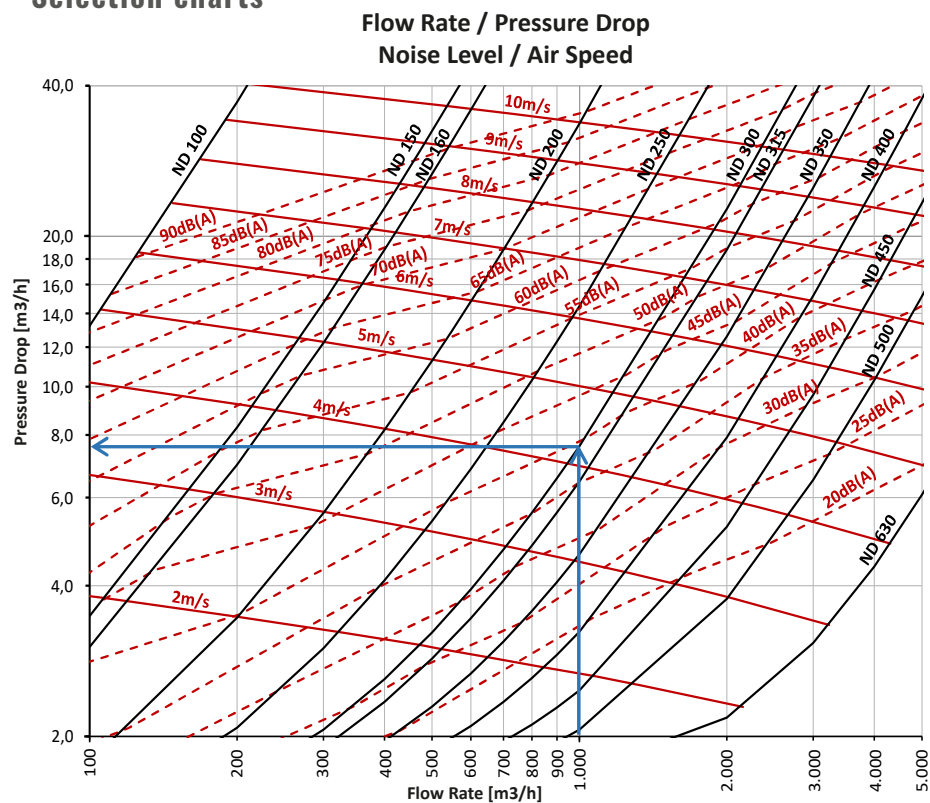

NOTE: Pressure drop data shown in the diagram refer to the diffuser with the damper fully open.

Diagram 1

The diagram shows the pressure drop of the diffuser based on the flow rate with relative indication of the noise level without environmental attenuation and speed of the incoming air flow.

Data referred to international standard atmosphere and measured according to the following regulations:

ISO 5801:2017	Aerulic Performance
ISO 5135:2020	Acoustic Performance
ISO 3741:2010	Acoustic Performance

CALCULATION (input data)	
Total Flow Rate	4.000m ³ /h
Max. Noise Level	55dB(A)
Number of diffusers expected	10pc
Throw	2,20m

SELECTION	
Model	DCMC 200
Flow Rate	400m ³ /h
Pressure Drop	+/-8Pa
Noise Level	55dB(A)
Air Speed	4,0m/s
Isothermal Throw	+/- 2,20m

Diagram 2

The diagram shows the isothermal launch of the diffuser according to the flow rate with terminal speed (Vt) of 0,25m/s. The horizontal launch data are to be understood in isothermal conditions.

For $\Delta T < 10^{\circ}\text{C}$ multiply the horizontal throw by 0,85.

MODEL	DESCRIPTION	U.M.	Vi (m/s)									
			1	2	3	4	5	6	7	8	9	10
100 Ak 0,0059m ²	Flow Rate	m ³ /h	21	42	63	84	105	127	148	169	190	211
	Pressure Drop	Pa	1,8	4,2	7,1	10,5	14,3	18,5	23,3	28,5	34,2	40,3
	Horizontal Throw Vt 0,25	mt	0,2	0,4	0,6	0,8	1,0	1,2	1,4	1,6	1,8	2,0
	Noise Level	dB(A)	52	60	68	75	83	91	98	106	114	121
	Min. Installation height	mt	2,5	2,6	2,7	2,8	2,9	3,0	3,1	3,2	3,3	3,4
	Max. Installation height	mt	3,2	3,3	3,4	3,5	3,6	3,7	3,8	3,9	4,0	4,1
150 Ak 0,0149m ²	Flow Rate	m ³ /h	54	107	161	215	268	322	376	429	483	537
	Pressure Drop	Pa	1,8	3,8	6,2	9,1	12,5	16,3	20,7	25,4	30,7	36,4
	Horizontal Throw Vt 0,25	mt	0,4	0,7	1,1	1,5	1,9	2,2	2,6	3,0	3,3	3,7
	Noise Level	dB(A)	38	45	52	59	66	72	79	86	93	100
	Min. Installation height	mt	2,5	2,6	2,7	2,8	2,9	3,0	3,1	3,2	3,3	3,4
	Max. Installation height	mt	3,2	3,3	3,4	3,5	3,6	3,7	3,8	3,9	4,0	4,1
160 Ak 0,0167m ²	Flow Rate	m ³ /h	60	120	181	241	301	361	421	482	542	602
	Pressure Drop	Pa	1,8	3,7	6,1	9,0	12,3	16,1	20,3	25,1	30,3	35,9
	Horizontal Throw Vt 0,25	mt	0,4	0,8	1,2	1,7	2,1	2,5	2,9	3,3	3,7	4,1
	Noise Level	dB(A)	36	43	50	57	63	70	77	84	90	97
	Min. Installation height	mt	2,5	2,6	2,7	2,8	2,9	3,0	3,1	3,2	3,3	3,4
	Max. Installation height	mt	3,2	3,3	3,4	3,5	3,6	3,7	3,8	3,9	4,0	4,1
200 Ak 0,0279m ²	Flow Rate	m ³ /h	100	201	301	402	502	602	703	803	904	1.004
	Pressure Drop	Pa	1,8	3,5	5,6	8,2	11,3	14,9	18,9	23,4	28,4	33,8
	Horizontal Throw Vt 0,25	mt	0,6	1,2	1,7	2,3	2,9	3,5	4,0	4,6	5,2	5,8
	Noise Level	dB(A)	34	40	46	52	58	64	70	76	82	88
	Min. Installation height	mt	2,5	2,6	2,7	2,8	2,9	3,0	3,1	3,2	3,3	3,4
	Max. Installation height	mt	3,2	3,3	3,4	3,5	3,6	3,7	3,8	3,9	4,0	4,1
250 Ak 0,0448m ²	Flow Rate	m ³ /h	161	323	484	645	806	968	1.129	1.290	1.452	1.613
	Pressure Drop	Pa	1,8	3,2	5,2	7,6	10,4	13,8	17,6	21,8	26,6	31,8
	Horizontal Throw Vt 0,25	mt	0,8	1,6	2,4	3,2	4,1	4,9	5,7	6,5	7,3	8,1
	Noise Level	dB(A)	27	33	38	44	49	55	61	66	72	77
	Min. Installation height	mt	2,5	2,6	2,7	2,8	2,9	3,0	3,1	3,2	3,3	3,4
	Max. Installation height	mt	3,2	3,3	3,4	3,5	3,6	3,7	3,8	3,9	4,0	4,1
300 Ak 0,0656m ²	Flow Rate	m ³ /h	236	473	709	945	1.181	1.418	1.654	1.890	2.126	2.363
	Pressure Drop	Pa	1,8	3,0	4,8	7,0	9,7	12,9	16,5	20,6	25,2	30,2
	Horizontal Throw Vt 0,25	mt	1,1	2,1	3,2	4,2	5,3	6,3	7,4	8,4	9,5	10,5
	Noise Level	dB(A)	23	28	33	38	43	49	54	59	64	70
	Min. Installation height	mt	2,5	2,6	2,7	2,8	2,9	3,0	3,1	3,2	3,3	3,4
	Max. Installation height	mt	3,2	3,3	3,4	3,5	3,6	3,7	3,8	3,9	4,0	4,1
315 Ak 0,0727m ²	Flow Rate	m ³ /h	262	523	785	1.046	1.308	1.569	1.831	2.092	2.354	2.615
	Pressure Drop	Pa	1,7	3,0	4,7	6,9	9,5	12,6	16,2	20,3	24,8	29,8
	Horizontal Throw Vt 0,25	mt	1,1	2,3	3,4	4,5	5,7	6,8	7,9	9,1	10,2	11,3
	Noise Level	dB(A)	21	26	31	36	41	46	51	57	62	67
	Min. Installation height	mt	2,5	2,6	2,7	2,8	2,9	3,0	3,1	3,2	3,3	3,4
	Max. Installation height	mt	3,2	3,3	3,4	3,5	3,6	3,7	3,8	3,9	4,0	4,1
350 Ak 0,0904m ²	Flow Rate	m ³ /h	325	651	976	1.302	1.627	1.952	2.278	2.603	2.929	3.254
	Pressure Drop	Pa	1,7	2,9	4,5	6,6	9,1	12,1	15,6	19,6	24,0	28,9
	Horizontal Throw Vt 0,25	mt	1,3	2,6	4,0	5,3	6,6	7,9	9,2	10,6	11,9	13,2
	Noise Level	dB(A)	<20	23	28	33	38	43	48	53	58	63
	Min. Installation height	mt	2,5	2,6	2,7	2,8	2,9	3,0	3,1	3,2	3,3	3,4
	Max. Installation height	mt	3,2	3,3	3,4	3,5	3,6	3,7	3,8	3,9	4,0	4,1
400 Ak 0,1175m ²	Flow Rate	m ³ /h	423	846	1.269	1.692	2.116	2.539	2.962	3.385	3.808	4.231
	Pressure Drop	Pa	1,7	2,7	4,2	6,2	8,6	11,5	14,9	18,7	23,0	27,8
	Horizontal Throw Vt 0,25	mt	1,6	3,2	4,7	6,3	7,9	9,5	11,1	12,7	14,2	15,8
	Noise Level	dB(A)	<20	<20	22	27	32	37	41	46	51	56
	Min. Installation height	mt	2,5	2,6	2,7	2,8	2,9	3,0	3,1	3,2	3,3	3,4
	Max. Installation height	mt	3,2	3,3	3,4	3,5	3,6	3,7	3,8	3,9	4,0	4,1
450 Ak 0,1500m ²	Flow Rate	m ³ /h	540	1.080	1.620	2.160	2.700	3.240	3.780	4.320	4.860	5.400
	Pressure Drop	Pa	1,7	2,6	4,0	5,8	8,1	10,9	14,2	17,9	22,1	26,7
	Horizontal Throw Vt 0,25	mt	1,9	3,7	5,6	7,4	9,3	11,1	13,0	14,8	16,7	18,6
	Noise Level	dB(A)	<20	<20	<20	24	28	33	37	42	46	51
	Min. Installation height	mt	2,5	2,6	2,7	2,8	2,9	3,0	3,1	3,2	3,3	3,4
	Max. Installation height	mt	3,2	3,3	3,4	3,5	3,6	3,7	3,8	3,9	4,0	4,1
500 Ak 0,1864m ²	Flow Rate	m ³ /h	671	1.342	2.013	2.684	3.355	4.026	4.697	5.368	6.039	6.710
	Pressure Drop	Pa	1,7	2,5	3,8	5,5	7,7	10,4	13,6	17,2	21,3	25,8
	Horizontal Throw Vt 0,25	mt	2,1	4,3	6,4	8,6	10,7	12,9	15,0	17,2	19,3	21,5
	Noise Level	dB(A)	<20	<20	<20	21	26	30	34	38	43	47
	Min. Installation height	mt	2,5	2,6	2,7	2,8	2,9	3,0	3,1	3,2	3,3	3,4
	Max. Installation height	mt	3,2	3,3	3,4	3,5	3,6	3,7	3,8	3,9	4,0	4,1
630 Ak 0,2994m ²	Flow Rate	m ³ /h	1.078	2.156	3.233	4.311	5.389	6.467	7.545	8.622	9.700	10.778
	Pressure Drop	Pa	1,7	2,3	3,3	4,9	6,8	9,3	12,2	15,6	19,5	23,8
	Horizontal Throw Vt 0,25	mt	3,2	6,4	9,6	12,8	16,0	19,2	22,4	25,6	28,8	32,0
	Noise Level	dB(A)	<20	<20	<20	<20	<20	23	26	30	34	37
	Min. Installation height	mt	2,5	2,6	2,7	2,8	2,9	3,0	3,1	3,2	3,3	3,4
	Max. Installation height	mt	3,2	3,3	3,4	3,5	3,6	3,7	3,8	3,9	4,0	4,1

Note: the data indicated refer to operation in isothermal conditions

Data referring to atm. stands. measured according to: ISO 5801:2017 Aeracoustic Performance / ISO 5135:2020 Acoustic Performance / ISO 3741:2010 Acoustic Performance

INSTALLATION WITH CONNECTING SLEEVE AND BUTTERFLY DAMPER

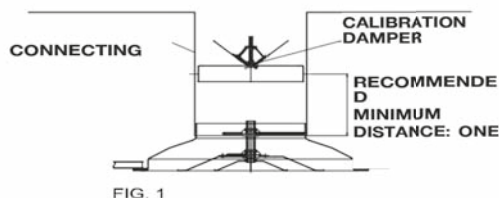

FIG. 1

INSTALLATION WITH FLEXIBLE HOSE AND BUTTERFLY DAMPER

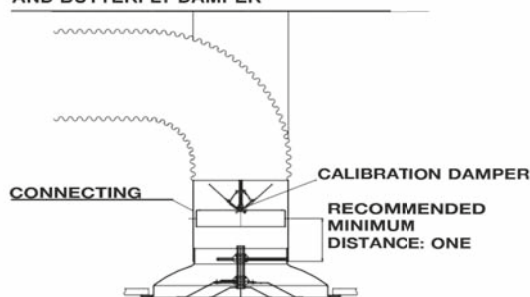

FIG. 2

INSTALLATION WITH CONNECTING SLEEVE AND COLLECTION DAMPER

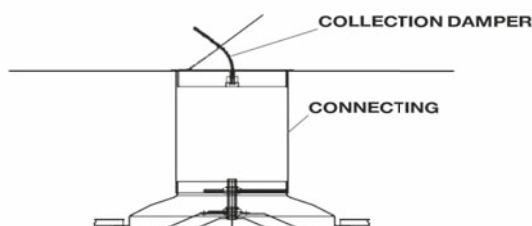

FIG. 3

Easy installation, adjustments and maintenance. The intermediate cones are easy to remove by turning the central hollow threaded pin. The damper fitted at the top of the diffuser is adjusted by acting on the adjustment screw through the hole in the threaded bar of the diffuser.

It is fastened to the ceiling by means of screws on the diffuser neck.

Adjustment

Central cone in low position: optimal position in cooling conditions in order to have the largest horizontal diffusion radius without creating discomfort in the occupied area in rooms with an ideal height between 3 and 4 m. With this configuration, you have the best pressure drop, velocity and sound level conditions. The maximum temperature difference (D) between the ambient air and the air flowing from the diffuser to obtain the optimal induction conditions is 12°C.

Central cone in high position: optimal position for particularly high rooms up to 6 m and in heating conditions, as you obtain a vertical throw that resists the convective motion of the ambient air.

Fig. 1 Installation with butterfly damper

- Fit the damper on the connecting sleeve, if possible keeping a distance with respect to the diffuser of one nominal diameter but not less than 5 cm.
- Unscrew the central cones from the diffuser and fasten the external housing on the connecting sleeve.
- Screw the central cones onto the external housing.
- Adjust the internal cones according to the desired diffusion parameters.
- Adjust the damper through the central hole in the threaded bar of the diffuser.

Fig. 2 Installation on flexible hose with butterfly damper

- Hang the diffuser on the ceiling or fasten it on the false ceiling.
- Fasten the damper on the connecting sleeve.
- Fit the connecting sleeve in the diffuser.
- Fit the flexible duct on the connecting sleeve and fasten it with a hose clamp.

Fig. 3 Installation with connecting sleeve and collection damper

- Fit the damper on the connecting sleeve in proximity of the hole in the main duct and fasten it with screws or rivets.
- Adjust the damper.
- Fasten the diffuser on the connecting sleeve.
- Finally adjust the flow rate by acting on the damper through the central hole in the threaded bar.